

Key Benefits & Features

- Based on ARM Microcontroller Platform
- Over Voltage and Over Current Protection
- IIC/SPI/SSC/OWI Communication Interface
- Provides 3.3V-5V High-current Power Supply
- Provides 3V-7V High-current Individual Voltage Controller
- USB Power Supply/Communication Interface
- Convenient Upper Computer Parameter programming



Applications

- MT6701CT Series
- MT6701QT Series

General Description

PB009 programmer provided by MagnTek is a new generation Encoder programmer developed based on Arm platform Cortex-M3 core. The programmer consists with stabilized voltage supply, voltage level translation circuit, microcontroller circuit and voltage level detection circuit. The USB power supply and communication interface make the programmer portable and easy to use. In normal use, the programmer connected with PC through USB interface, Chip connected with programmer with DB9 socket, then user could program the chip through the related upper computer on PC.

PB009 provides high-current voltage supply up to 7V, which could be used in various types of OTP/EEPROM programming.

Contents

1	PB009 PROGRAMMER HARDWARE -----	错误!未定义书签。
1.1	PB009 PROGRAMMER HARDWARE COMPONENTS-----	3
1.2	PB009 PROGRAMMER HARDWARE SET UP -----	4
2	SOFTWARE DRIVER INSTALLATION -----	错误!未定义书签。
3	SOFTWARE INTERFACE -----	错误!未定义书签。
4	SOFTWARE OPERATION -----	错误!未定义书签。
4.1	MANUAL DEBUGGING -----	错误!未定义书签。
4.2	AUTO PROGRAMMING-----	错误!未定义书签。
5	NOTE -----	17
6	VERSION HISTORY -----	错误!未定义书签。

1 PB009 Programmer Hardware

1.1 PB009 Programmer Hardware Components

PB009-MT6826S programmer suite consists with programmer host, socket adapter board and USB cable.

Datasheet, software and drive could be accessed on official website>' Technical support' >' Evaluation Board and Programmer' , please choose upper computer program matching the chip model.

Direct Link: <http://www.magntek.com.cn/36/>



Figure 1.1 PB009-MT6701CT Programmer Host

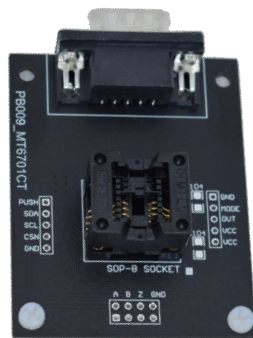

Figure 1.2 PB009-MT6701CT Socket Adapter Board



Figure 1.3 USB Cable

PB009-MT6701CT User Guided

1.2 PB009 Programmer Hardware Set up

- PB009 programmer could only program single piece of MT6701CT at the same time.
- PB009 programmer is connected to PC through USB cable.
- PB009-MT6701CT socket adapter board is linked to programmer through DB9 connector.
- The mark point on MT6701CT should be aligned at the white square mark on socket adapter board when putting the chip into the socket.
- The three steps above are all hardware set up between PB009 programmer and MT6701CT, after the set up finished the power source of programmer could be switched on for chip parameter configuration.
- Due to the particularity of SPI transmission protocol, PB009 programmer suite is mainly used in chip parameter configuration in R&D , it is not recommended to use the programmer suite directly in small batch production or even batch production. In case of special circumstances when the PB009 programmer suite has to be used in small batch production, it should strictly obey the following requirements:
 - ◆ It is strictly prohibited to weld ordinary wires to the marked wiring end on the socket to chip for programming;
 - ◆ The DB9 connector pin and chip must be connected by shielded cable, DB9 connector pin assignment could be seen in table 1.1 ;

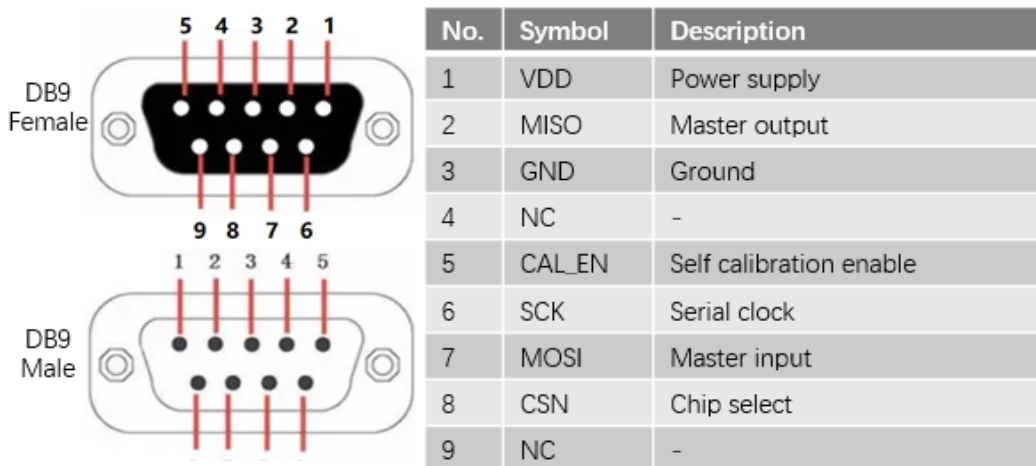

Table 1.1 DB9 Pin Assignment

PB009-MT6701CT User Guided

- ◆ The shielded wire should use harness with shielding metal layer. The wire diameter should be greater than 0.2mm and length smaller than 60mm. One end of the shielding metal layer should be connected to D89 metal shell and the other end connected to GND on PCB;
- ◆ If the PCB with MT6701CT is installed on the top of motor shaft with high current(step/servo motor) and it is required to be programmed while the motor is powered on(motor online zero tuning), please reduce the motor current in order to reduce the interference on chip programming. If the motor current could not be reduced, please use shield cable with larger wire diameter and shorter length to connect chip and programmer.
- ◆ Please use "Auto programming" GUI on corresponding upper computer to ensure the correctness of chip data burning.
- If the steps below could not satisfy the requirement of small batch production, please contact our relevant personal at the first time to solve the problem.

2 Software Driver Installation

- Unzipped the downloaded file.
- Open the "CH340SER.rar" in folder and unzip.
- Double click the "SETUP.exe" file in folder and install the driver.
- After installation finished, power on the programmer and connect it to PC at the same time through USB cable. Then in "This PC → Setting → Devices Manager → Port(COM and LPT)" to ensure whether the driver is installed successfully, diagram 2.1.
- Based on user PC disposition to choose "CH340SER" (XP/WIN7/WIN10-32bit) or "CH341SER" (WIN7-64bit/WIN10) to install, it is recommend to install CH340SER for Win10 32bit system, if there is driver combability issue exist, try to install CH341SER.
- If both of the two driver could not work properly, try to change another PC or contact our relevant personal to solve the problem.

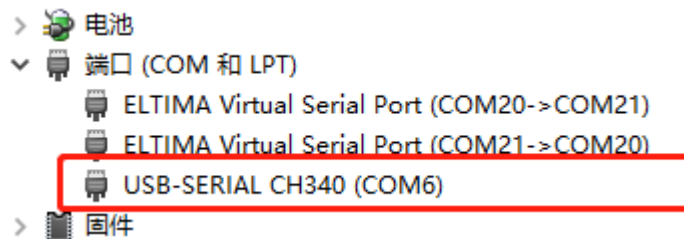



Figure 2.1 Driver Successful Installed and Plugged to Programmer

3 Software Interface

This part mainly focus on the instruction of MT6701CT programmer software, the definition of particular parameter is indicated in the software interface or MT6701CT datasheet.

- Recommended operating environment: windows7 or above (.net Framework 3.5 or above); Memory 512M or above; Hard disk 2G or above; the monitor and GPU should support 1024×768, 60Hz .
- The software is a portable software and no installation requirement.
- The software will create log file in current directory when it is operated. If the software is installed in folder with administrator privileges, administrative access is required to run the software.
- User could download latest version from official website.
- Unzipped the file to access the software  PB009-MT6701CT上位机软件
- Double click the software icon to enter the program interface, the default interface is auto programming (factory mode).
- Click the 'Auto Programming ' icon in diagram 3.1.1, Select ' Manual debugging ' in drop menu, the interface will be switched to Manual debugging (3.1.2). In the same way the interface could be switched back to Auto programming.
- In avoid of mis operation in interface switch in production mode, a password is required when entering "Manual debugging" from "Auto programming" . The default password is "123456" .

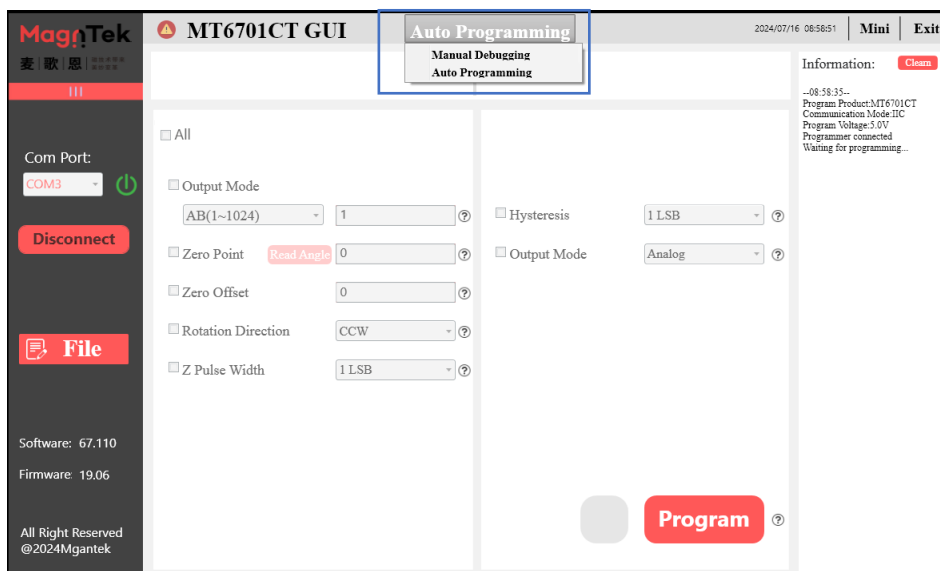

Figure 3.1.1 Program Interface Switch Selection

PB009-MT6701CT User Guided

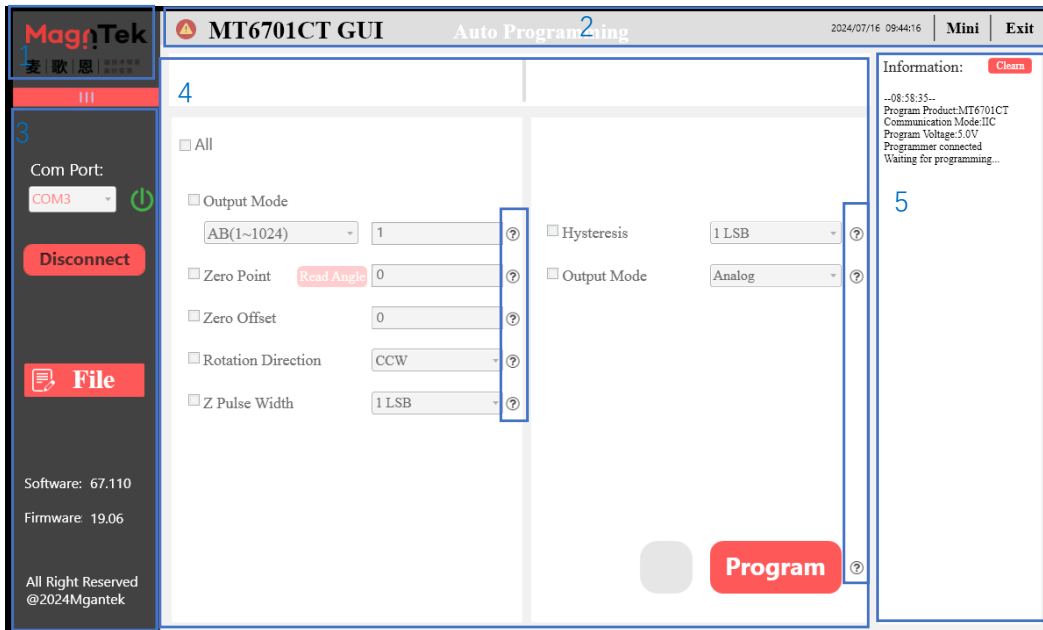

Figure 3.1.2 MT6701CT Manual Debugging Interface

- 1 MagnTek logo, Click to directly enter official website “Technical assistance” interface.
- 2 The title bar of the interface, the chip model displayed is the programmable chip type, the chip model should matching the software model when programming. The relevant precautions of current software could be checked by clicking the icon in the front.
- 3 Set the connection between programmer and PC, when using PB009 programmer at a proper COM, click the “connect” icon could build connection between the programmer hardware and software interface and update the firmware version number. The firmware version number is read back from the programmer, the software version number only shows current software version. The “File” icon could be used in import/outport profiles in form of x.txt.
- 4 This area is the operation area of chip parameter programming, user will operate in this area most of time. Unless the power source of programmer is switched off or the USB cable was unplugged, there is no need to click “Connect” icon. User could power on/off the chip, set parameters and burn programming in this area. Please refer to Section 4(page 10) for detailed operation process of this area.
- The “?” icon in area 4 is the annotation of corresponding parameter. As it is shown in diagram 3.1.3 and 3.1.4, if icon “?” is clicked the description of AB resolution will pop up, including parameter information, spec and corresponding register address. Each “?” icon is related to one parameter annotation which is available for users to consult. For more details please check datasheet for each model.

PB009-MT6701CT User Guided

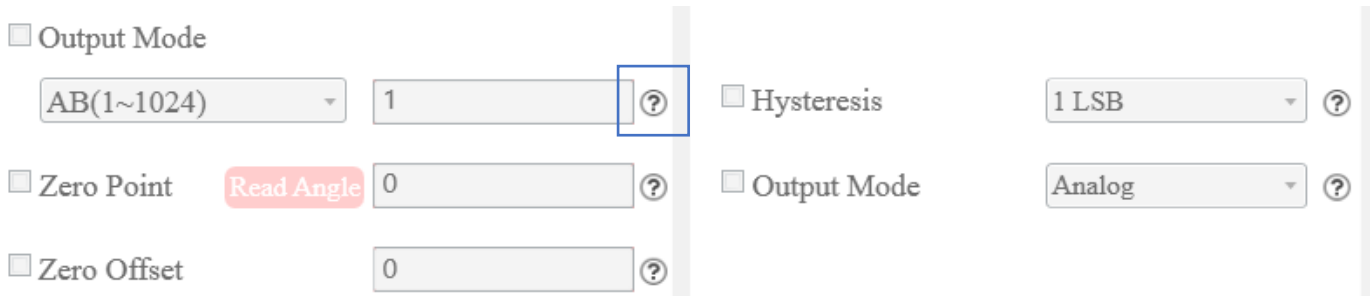

Figure 3.1.3 Click 'AB Resolution' corresponding '?' icon

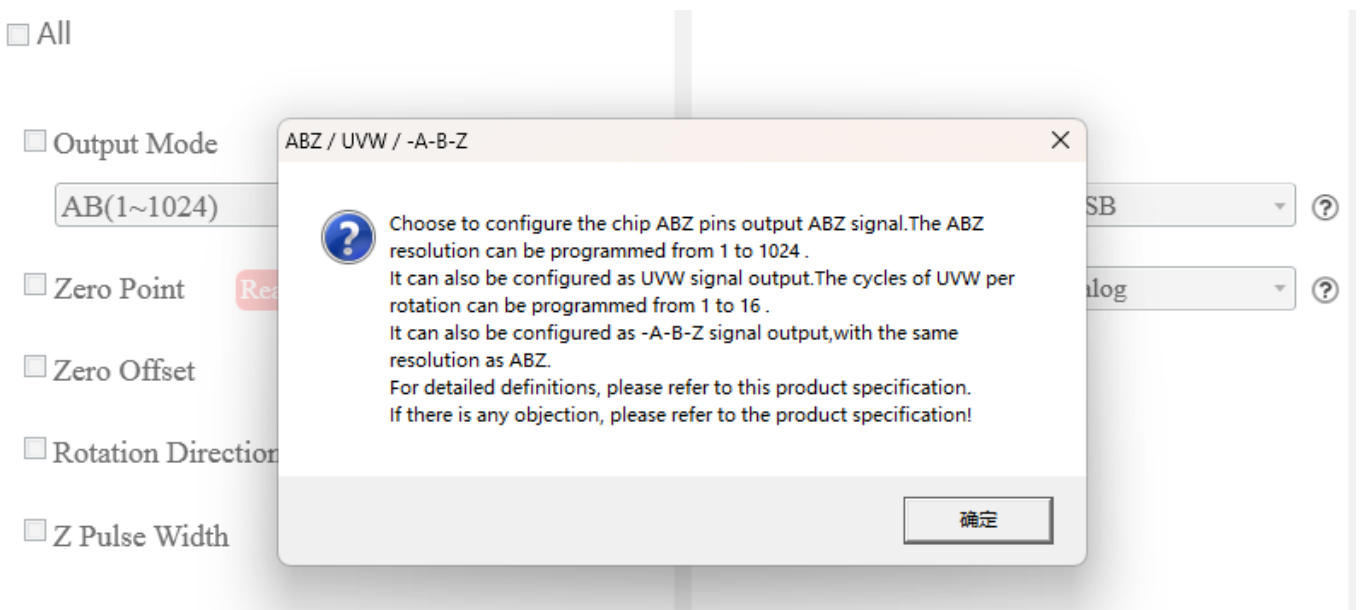

Figure 3.1.4 The AB resolution annotation appear on interface

- 5 is status information, which shows the user history operation and corresponding returned result. Click "clear" icon on right upper corner could manually delete current status information. (the deleted information could not be restored)

4 Software Operation

4.1 Manual Debugging

The following parameters are used to demonstrate MT6701CT programming with the software interface. All other cases refer to this example and software instruction above .

Configuration parameter: ABZ output resolution 1024、 Zero point offset 20deg、 Z pulse width 16 LSB、 Rotation direction counter clockwise、 PWM output、 PWM frequency 500Hz、 PWM polarity low level valid.

- 1、 Connect PC and PB009 programmer with USB cable, switch on the power source of programmer, the Green indicator LED will stay on after blinking two times.
- 2、 Double click "PB009GUI_v26.02.exe" , run the software.
- 3、 Connect Socket adapter board to PB009 programmer DB9 connector, make sure that Socket adapter board model match the chip model.
- 4、 Click the drop-down list below "COM port" icon, click "Connect" icon, build up connection between PC and programmer. (Figure 4.1.1, 4.1.2, 4.1.3) .

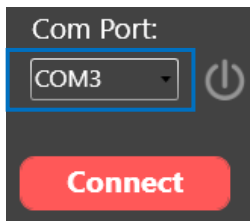
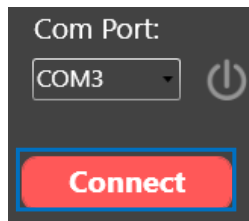
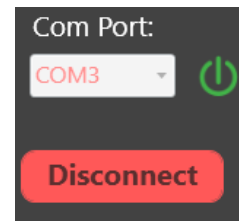

Figure 4.1.1 Select COM port



4.1.2 Click 'Connect' icon



4.1.3 PB009 working condition

- 5、 Alian the chip in Socket directly or connect the wire on chip test PCB to socket adapter board, the pin assignment could refer the silk screen on test PCB.
- 6、 Click the power icon, the interface will switch to "power on" . The checkboxes and buttons will change to operable state. The information bar will display the chip current configuration and light on the programmer blue indicator LED.

Note: When a chip requires programming, the chip must be connected to programmer before being powered on. Otherwise its output performance will be affected.



Figure 4.1.4 Power icon



4.1.5 Programmer indicator led

PB009-MT6701CT User Guided

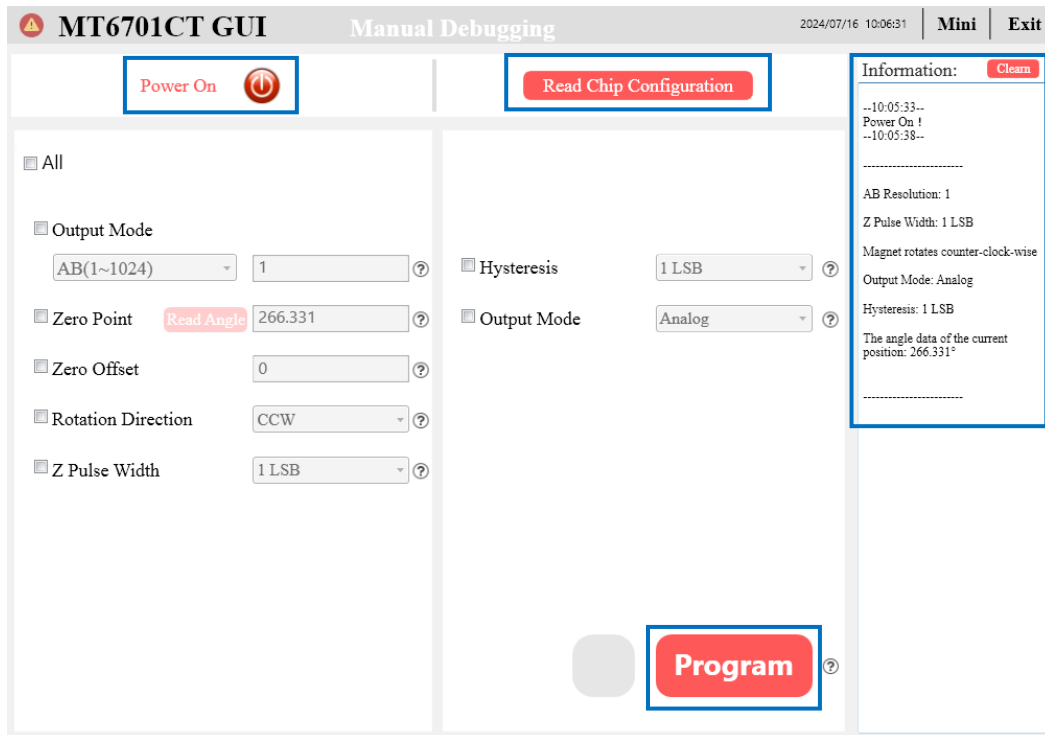

Figure 4.1.6 The interface state after chip power on

- 7、As it is shown in diagram 4.1.7, Click “Read Chip Configuration ” icon, programmer will return current chip configuration to information bar on right side, and refresh the left side option box to latest parameter.

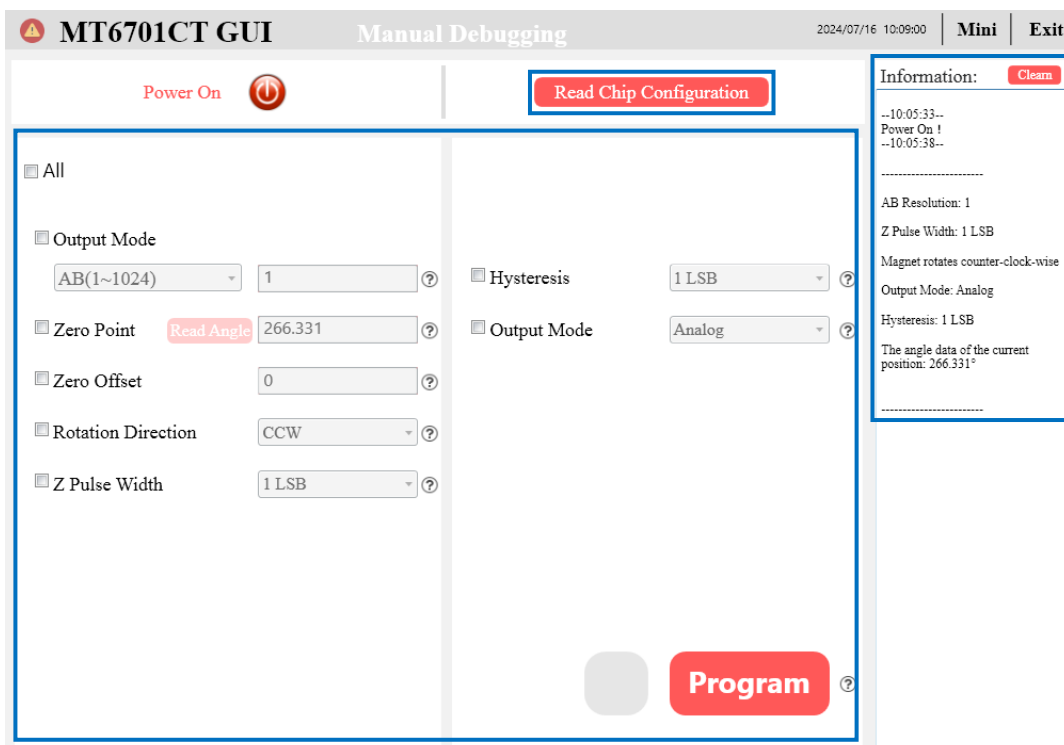

Figure 4.1.7 Read Chip Configuration

PB009-MT6701CT User Guided

- 8、 As it is shown in diagram 4.1.8. In Blue box 1 the checkbox of each parameter could be selected to activate wanted parameter setting box (Click "ALL" if all parameters are required)



图 4.1.8 读取芯片配置

- 9、 User could directly enter number in input box in blue box 2, here the AB resolution is 1024. If the box is drop-down selection bar it could be used to expand the option menu by clicking drop-down icon to select wanted parameter. As it is shown in diagram 4.1.9 the Z Pulse width is selected to be 6LSB、 PWM frequency 500HZ in the drop-down selection bar. Click 'Read angle' to display current chip measured angle value in information bar, Enter 20 degree in 'Zero offset' below. 'Hysteresis' have no programming requirements, so the box should be uncheck (The detailed parameter configuration requirements could be check by clicking the "?" icon beside input box. If further parameter instruction is required ,please refer the product datasheet.)

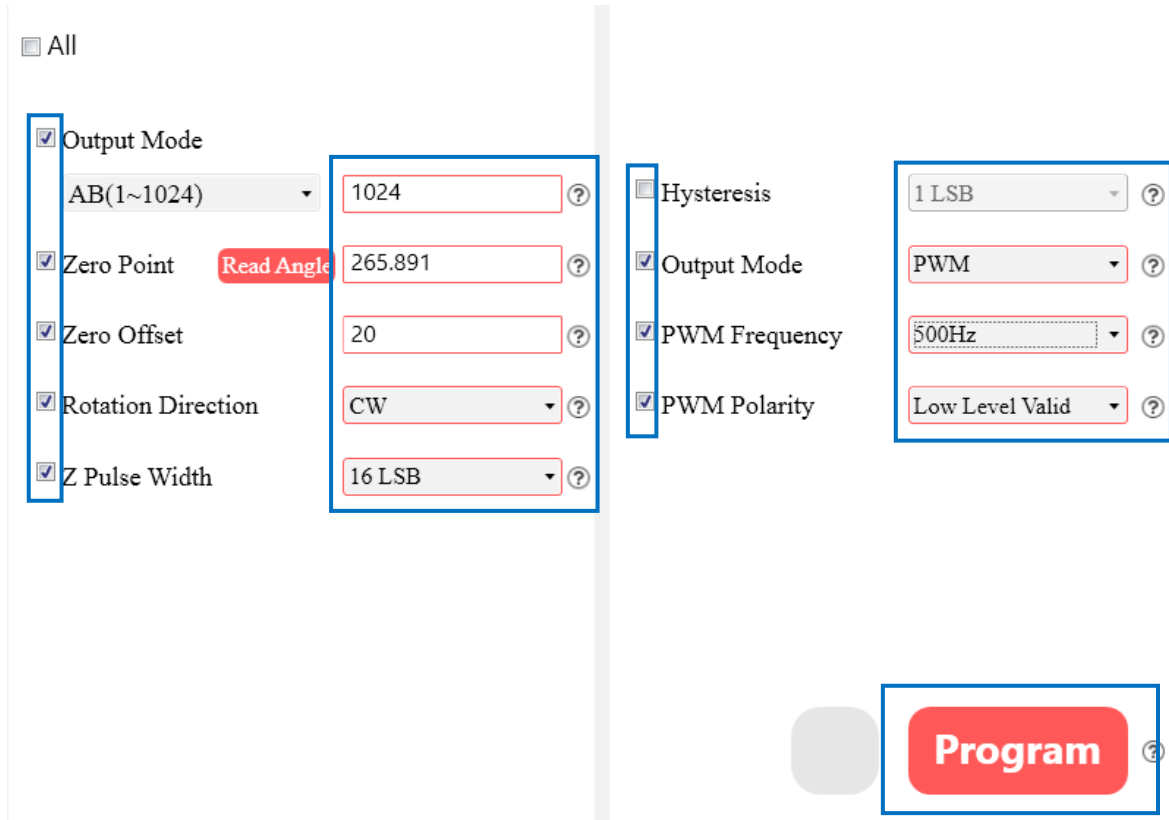
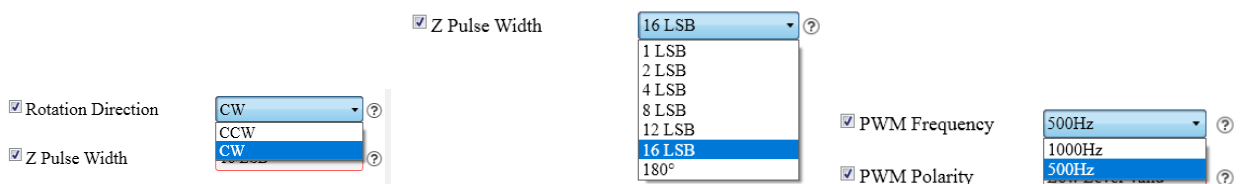

Figure 4.1.9 Drop down selection bar

PB009-MT6701CT User Guided

- After finishing the configuration of parameters above, click “Program” icon in Blue box 3 to burn the data into chip. During the process of burning, the parameters of the chip will be checked and validated many times, the blue indicator LED on programmer will blink two times. After the data burning finished the LED will put out. The status bar will show “PASS” (4.1.10) or “Fail” if programming failed(4.1.11)

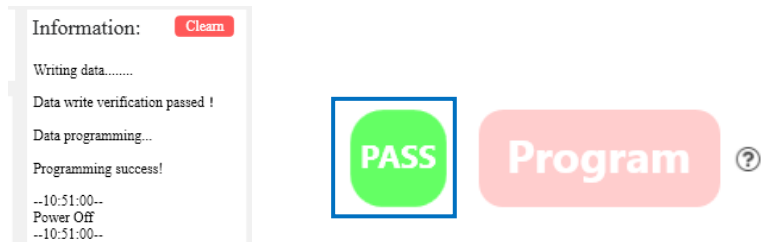

Figure 4.1.10 Program succeed, show “PASS”

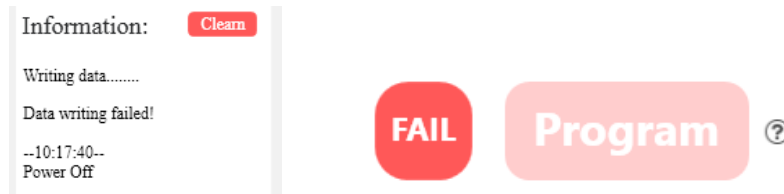

Figure 4.1.11 Program failed, show “Fail”

- After programming succeed, the chip will be powered off automatically and the indicator blue led will put out. Now the chip could be taken out from socket for normal use. The chip integrated in a complete system could disconnect the chip from programmer for use. After the chip power down, the programmer software interface will return to Non-programmable status.(4.1.12), and the information bar on right side will show current chip configuration at the same time.

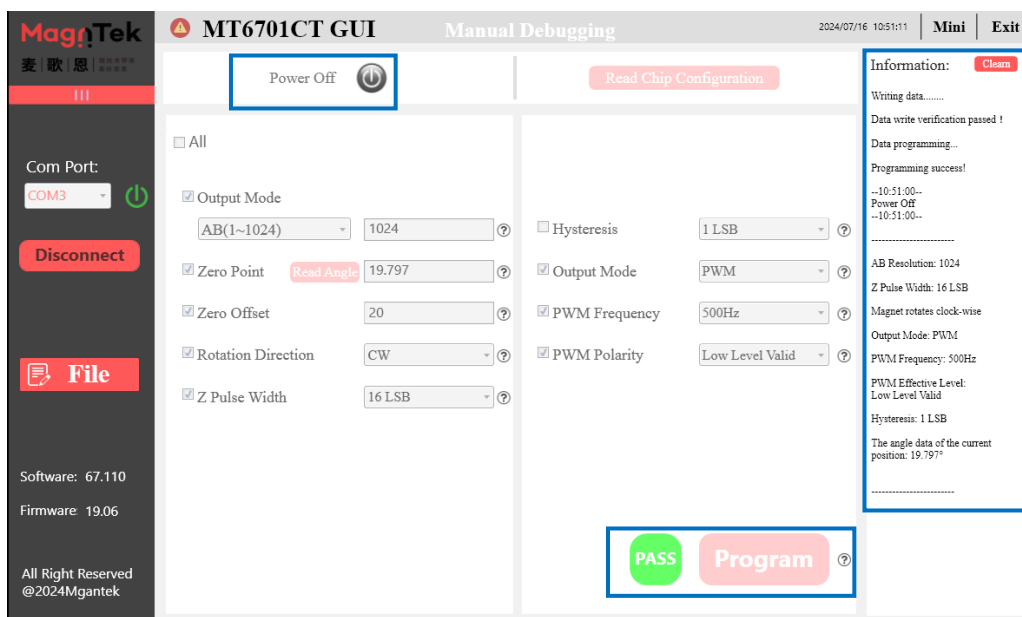

Figure 4.1.12 Software interface after chip power down

PB009-MT6701CT User Guided

- By repeating the step 5-11 above multiple chips could be programmed and test, or single chip could be manually programmed for multiple times.

4.2 Auto Programming

This software default interface is auto programming, it could be used in fast batch programming in factory. Parameters are fixed. The following instruction demonstrates its program process.

4.2.1 Parameter Setting and Saving

- Refer to section 4.1 step 1 to 5, make sure the chip is properly connected to programmer.
- Click the 'auto programming' as it is shown in 4.2.1, select "Manual debugging" in the drop-down list. Enter password '123456' switch to manual program interface.

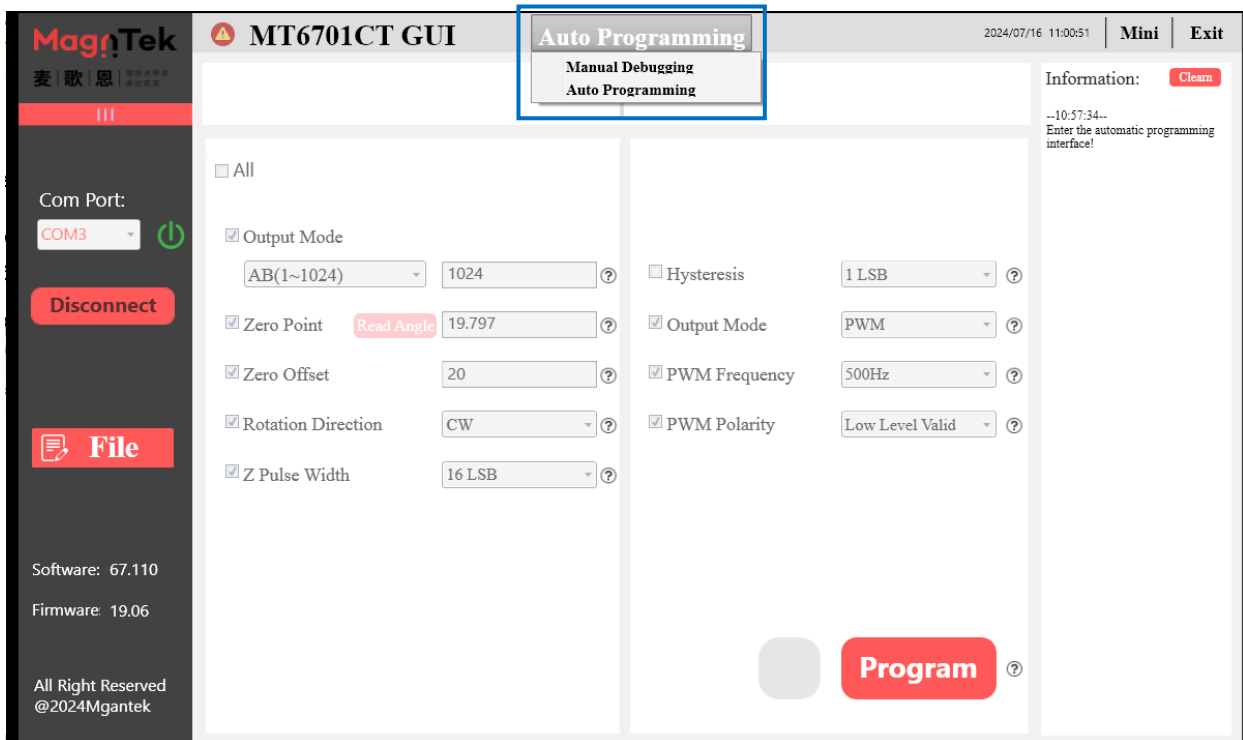

Figure 4.2.1 Auto programming interface to Manual debugging interface

- In manual debugging interface, refer to section 4.1 step 6 to 9 to power on the chip and set parameters.
- Click 'File' icon on left side, select 'Save settings' icon.(4.2.2)
- Select save path in pops up window, click 'Save' icon to save current configuration to x.txt file as it is shown in 4.2.3.

PB009-MT6701CT User Guided

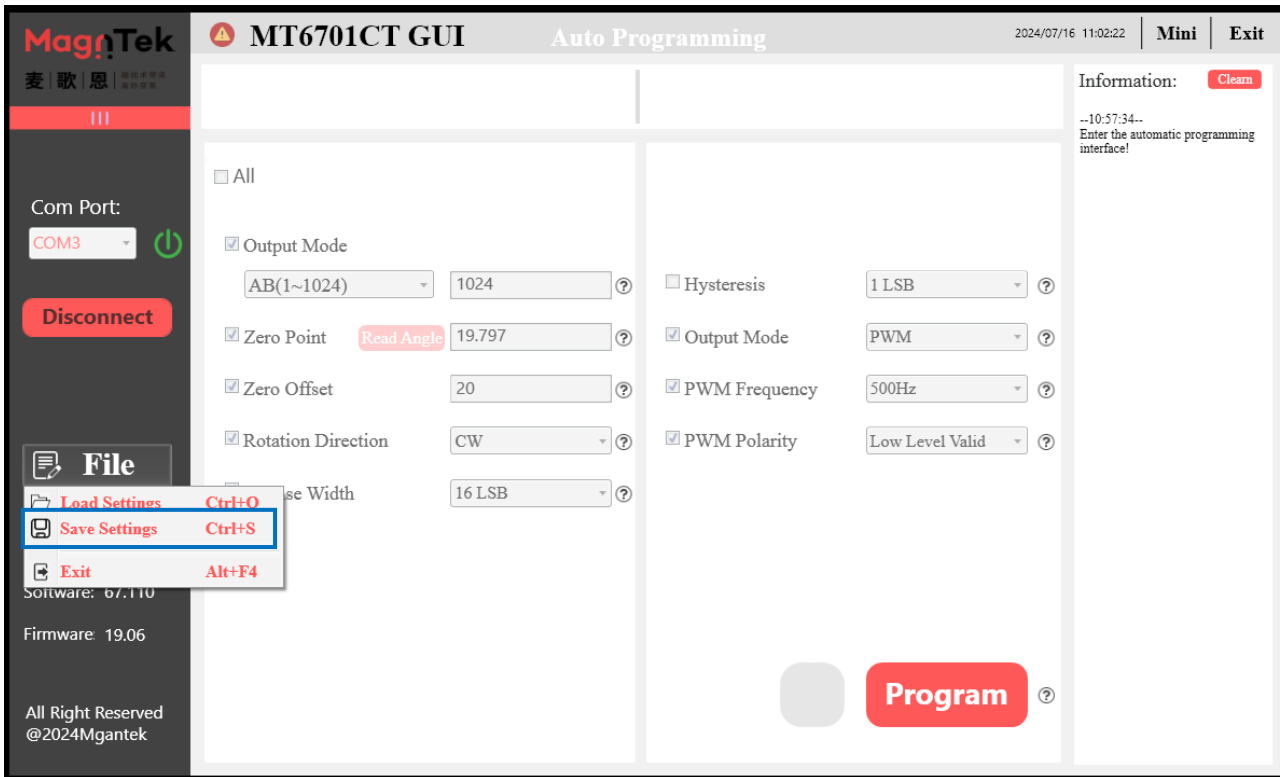

Figure 4.2.2 Set parameters and save the data

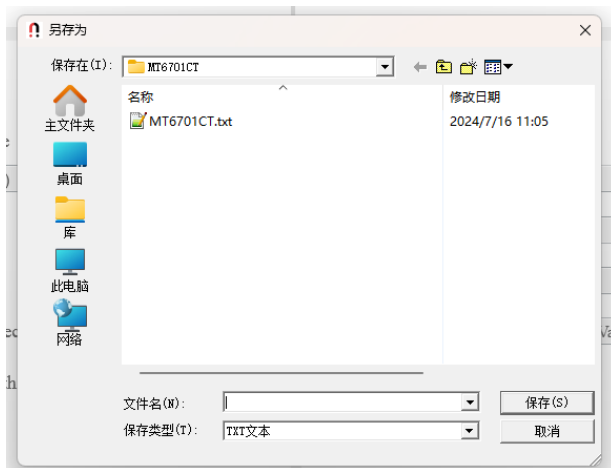

Figure 4.2.3 File save window

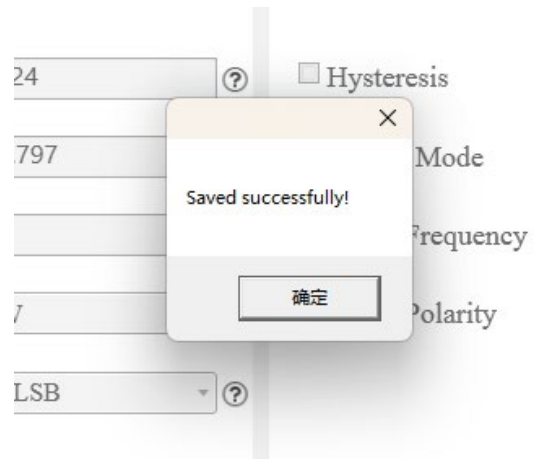

Figure 4.2.4 Parameters saving success

PB009-MT6701CT User Guided

4.2.2 Load Settings and Programming

- 1、 Refer to section 4.1 step 1 to 5, make sure the chip is properly connected to programmer.
- 2、 Run the software default interface ‘Auto Programming’ , the parameters could only get from loading settings. Click the ‘File’ in bar left side, select ‘Load settings’ in the drop-down list(4.2.5), select corresponding txt file in the pop up window(4.2.6) and click ‘Open’ icon to load the setting in the file to software interface. Refer to section 4.2.1 to review the way to create setting files.

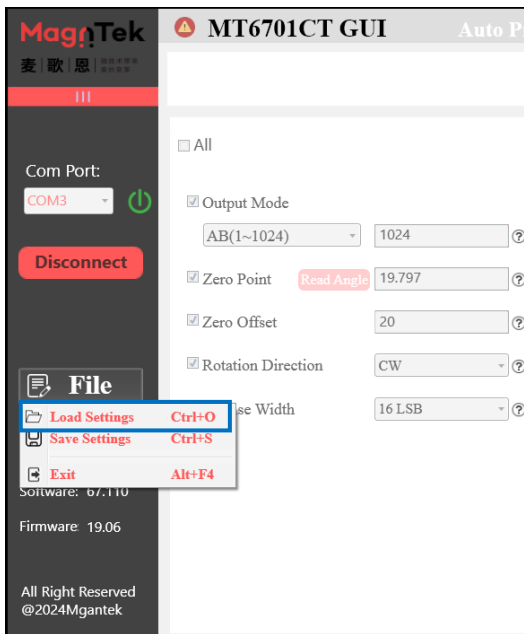
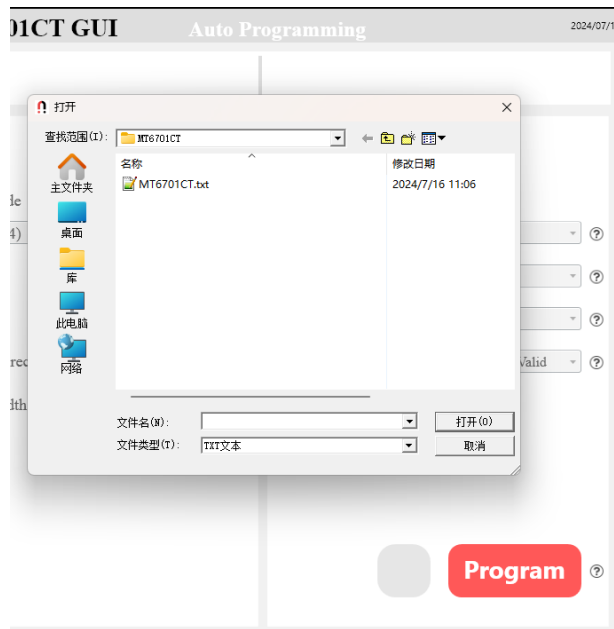

Figure 4.2.5 Load settings



4.2.6 Open file window

- 3、 Confirm the parameters are correct and then put the chip into socket, or connect the wire connected with chip on PCB to programmer corresponding port.
- 4、 Click ‘Program’ , the chip could be powered on, programmed, parameter testing and powered off.

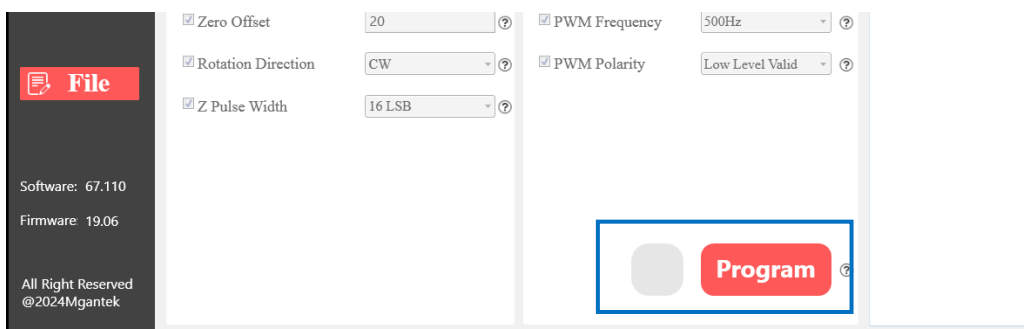

Figure 4.2.7 Click ‘program’ After Parameter Identification

PB009-MT6701CT User Guided

- After programming finished, the icon will show 'Pass' ; at the same time the information bar on right side will show the programmed chip configuration ; If programming failed the icon will show 'Fail' and pop up failure windows. After programming the chip will power off automatically, blue indicator led will go off.

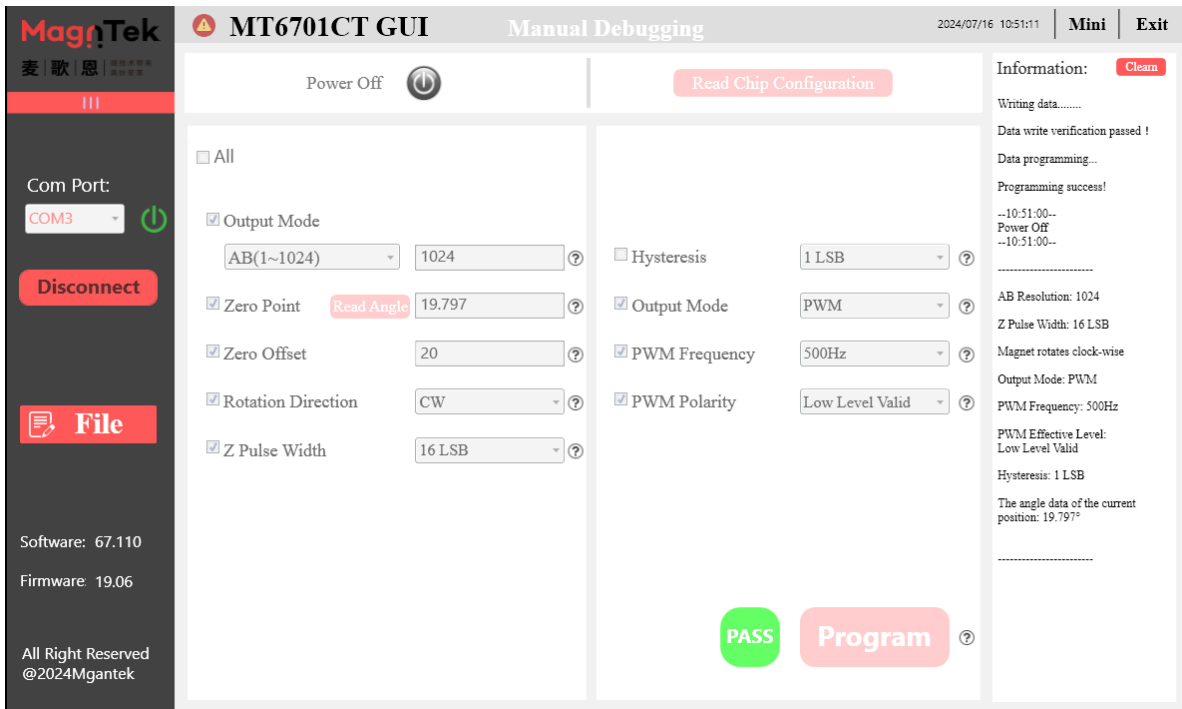

Figure 4.2.8 Programming finished interface

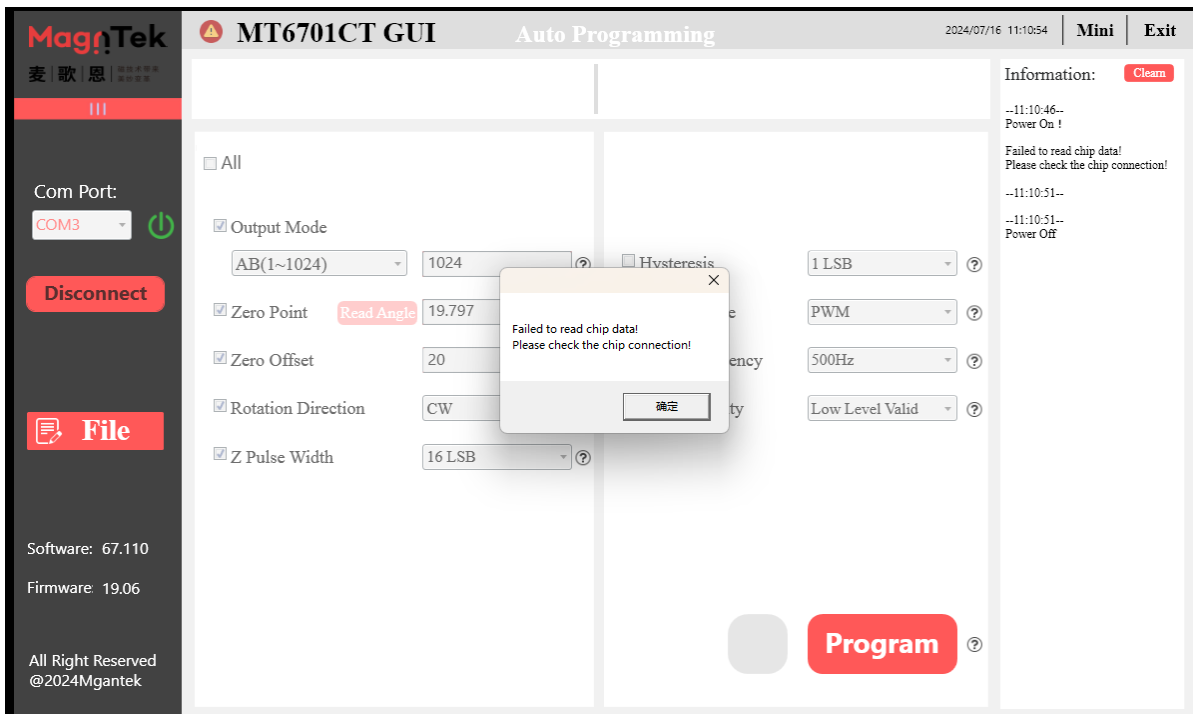

Figure 4.2.9 Programming failure interface

- Repeat step 4~5 to program multiple chips or program single chip for multiple times.

5 Notes

- If the programmer keeps in holding state for a long time, please switch off the main power and disconnect USB interface from PC for safety use.
- The programmer requires software and hardware adaptation, or it will report error or no response, the programmer could not work properly.
- The chip model should match the programmer software model, otherwise it will be easy to damage the chip.
- Make sure the programmer power source is switched off when replacing the chip in avoid of damaging the chip by hot plugging. The power source could be controlled on software interface and user could refer to the blue indicator LED to confirm the power source status.
- When the program interface is closed the programmer will switch off chip power source automatically to ensure a safety use.
- The operating sequence ‘Chip put into programmer’ → ‘Power on the chip’ → ‘Program the chip’ → ‘Power off the chip’ should be strictly obeyed for each chop when programming.
- It is strictly forbidden to replace chip under ‘power on’ situation, otherwise the chip performance will be affected.
- Due to the particularity of SPI transmission protocol, PB009 programmer suite is mainly used in chip parameter configuration in R&D, it is not recommended to use the programmer suite directly in small batch production or even batch production.
- In case of special circumstances when the PB009 programmer suite has to be used in small batch production.
- It is strictly prohibited to use ordinary wires from the marked wiring end on the socket to chip for programming;
- When programming the chip there will be various interference factor lead to the program result out of expectation or even lose function, so please reduce the effect from programming environment as far as possible, for example: keep the programmer away from the devices such as a working state motor or high power adapter.

6 Version History

Revision	Comments	Date
1.1	Formal Release	2023/01