

Data Acquisition System of NSPGS2

AN-12-0005

Author: Qiuliang Shi



Data Acquisition System of NSPGS2

ABSTRACT

NSPGS2 series are calibrated gauge pressure sensor which combines state-of-art MEMS sensor technology and CMOS mix-signal processing technology to produce an amplified, fully conditioned, multi-order pressure and temperature compensated sensor in a Small Outline Package (SOP) with tube port. This application note introduces a simple data acquisition system based on the NSPGS2 series pressure sensor demonstration board to help customers quickly use the data acquisition system to acquire pressure data.

INDEX

1.HARDWARE	2
1.1. HARDWARE OVERVIEW	2
1.2. SCHEMATIC	3
2. INSTALLING SOFTWARE	4
2.1. INSTALLING NI LABVIEW RUNTIME 2018	4
2.2. INSTALLING NI VISA 18.0	5
3.SOFTWARE DESCRIPTION	6
3.1. INTRODUCTION TO SOFTWARE INTERFACE	6
3.2. SOFTWARE OPERATING INSTRUCTIONS	7
4. REVISION HISTORY	9

Data Acquisition System of NSPGS2

1. Hardware

1.1. Hardware overview

This demo consists of two parts: main board & DUT. There is a MCU on main board to acquire, decode the output of pressure sensor and then transfer the data to PC or laptop. DUT with a NSPGS2 pressure sensor is connected to the main board to get power supply and feedback the output.

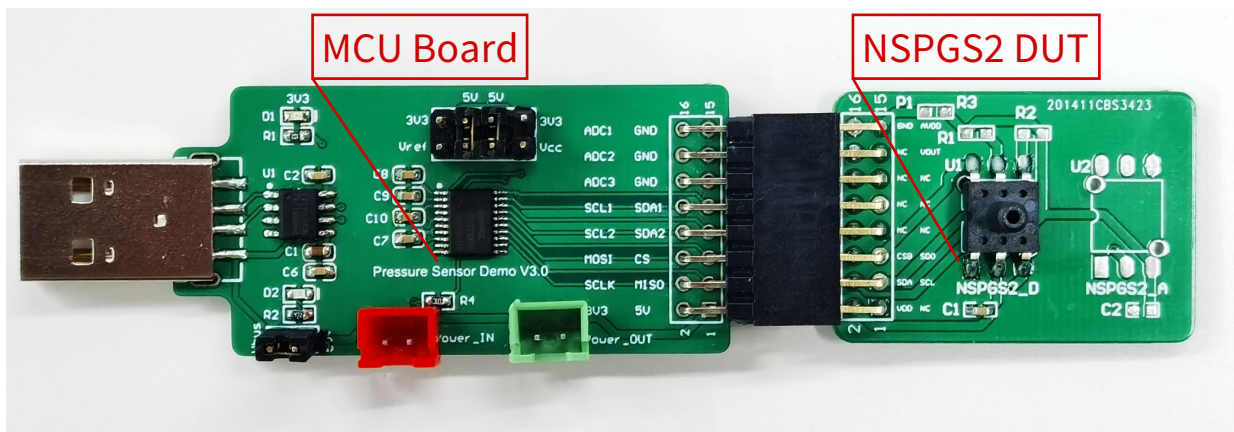

Figure 1. NSPGS2 series pressure sensor demo board

The demo board is shown in above figure, the main board could be connected to different type of sensors.

- Free choice of power supply: direct USB power or individual power source: 3.3V~5.5V.
- Multiple types of output supported: analog voltage, frequency, OWI, I2C, SPI.
- On board 3.3V power source available.

Data Acquisition System of NSPGS2

1.2.Schematic

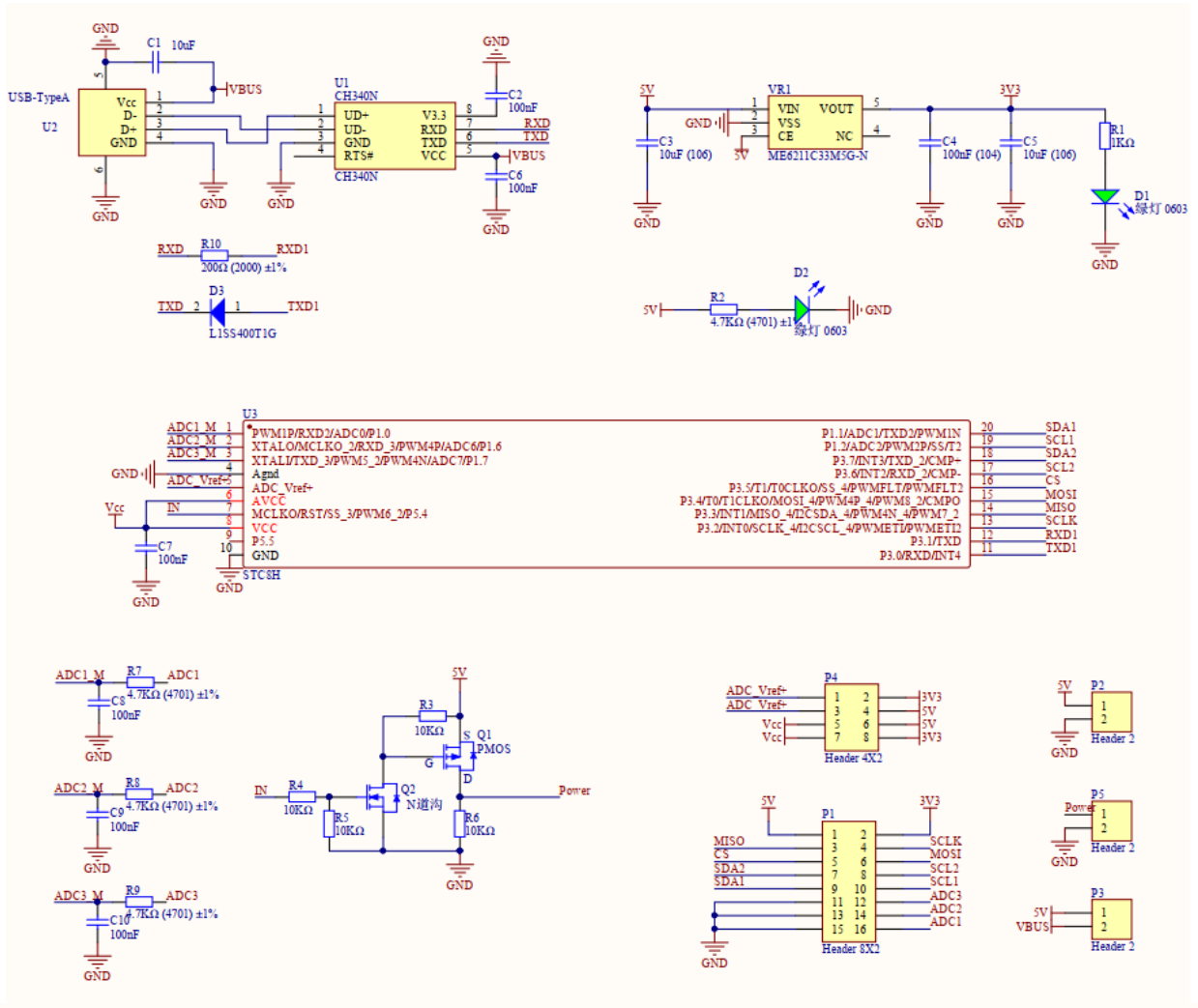

Figure 2. Schematic of NSPGS2 series pressure sensor demo board

Data Acquisition System of NSPGS2

2.Installing software

2.1.Installing NI LabVIEW runtime 2018

Go to the website <https://www.ni.com/zh-cn/support/downloads/software-products/download.labview-runtime.html#359578> and download the NI LabVIEW Runtime 2018.

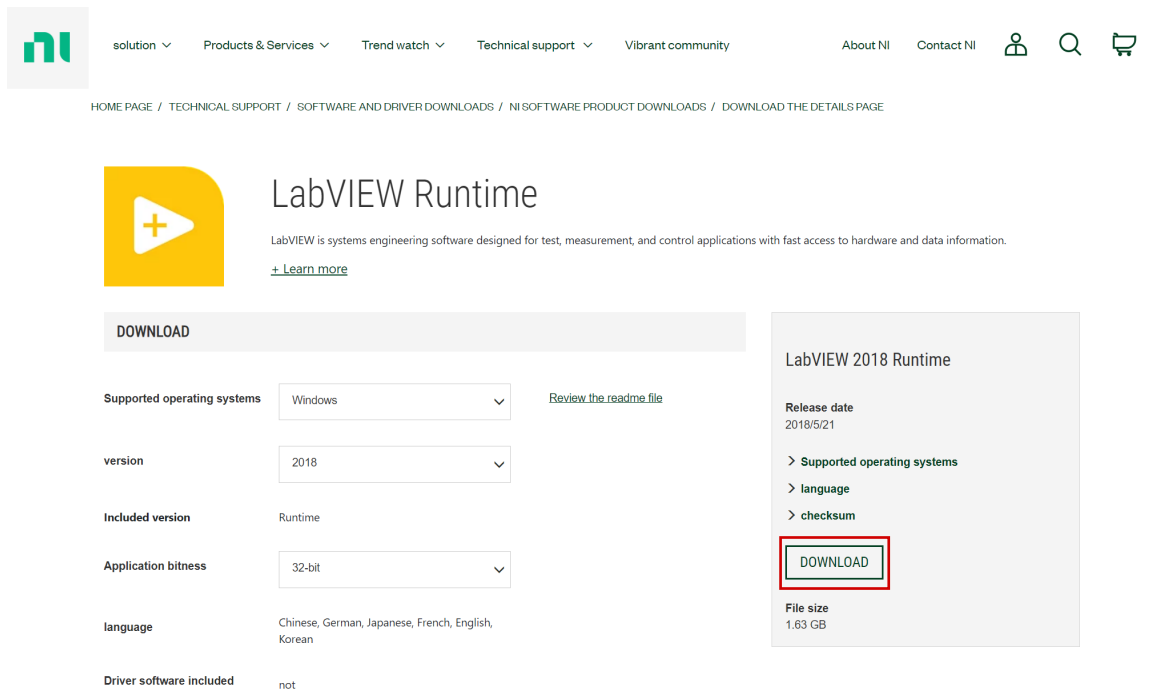

Figure 3. NI LabVIEW runtime package on NI website

After decompressing, double-click the setup to install and follow the instructions to finish install.

Bin	2018/10/17 14:27	文件夹	
Licenses	2018/10/17 14:27	文件夹	
Products	2018/10/17 14:27	文件夹	
nidist.id	2018/9/25 13:42	ID 文件	1 KB
patents.txt	2018/9/4 14:42	文本文档	24 KB
setup.exe	2018/9/19 17:23	应用程序	1,445 KB
setup.ini	2018/9/25 13:42	配置设置	28 KB

Figure 4. View of the installation folder

Data Acquisition System of NSPGS2

2.2.Installing NI VISA 18.0

Go to the website <https://www.ni.com/zh-cn/support/downloads/drivers/download.ni-visa.html#306041> and download the NI VISA Runtime 18.0.

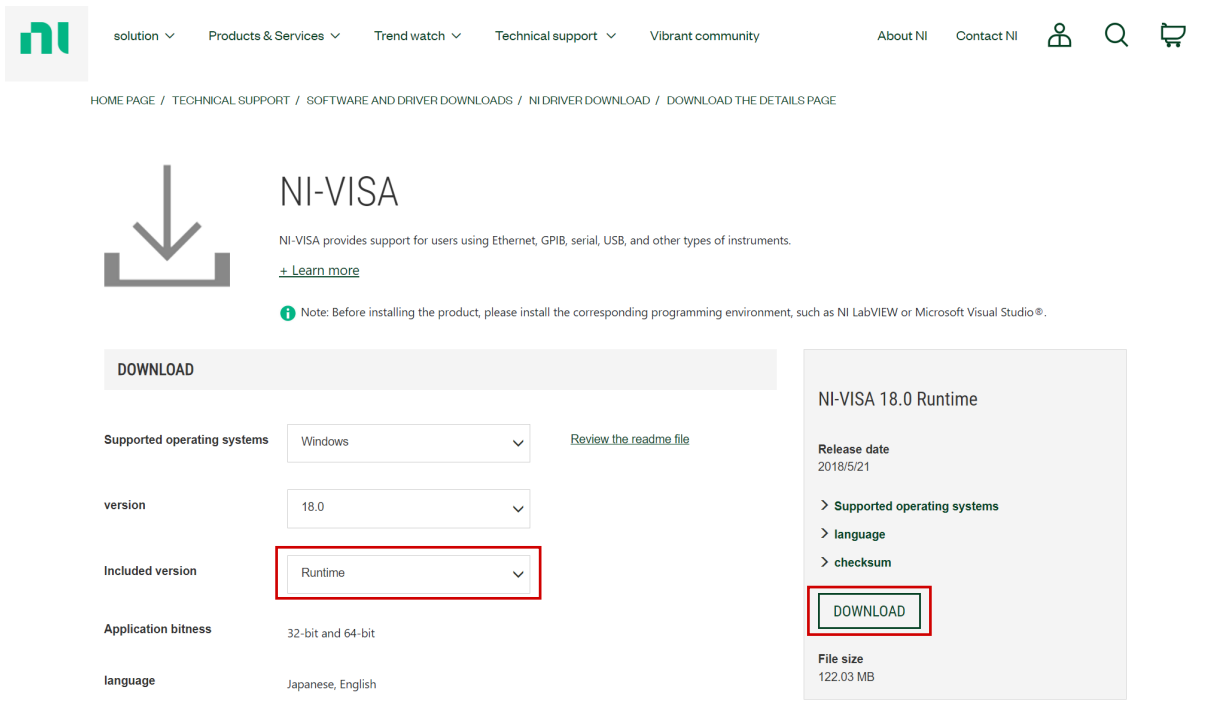

Figure 5. NI VISA 18.0 package on NI website

After decompressing, double-click the setup to install and follow the instructions to finish install.

license	2023/3/2 10:53	文件夹	
Products	2023/3/2 10:53	文件夹	
SupportFiles	2023/3/2 10:53	文件夹	
nidist.id	2019/6/21 10:15	ID 文件	1 KB
patents.txt	2019/6/21 10:15	文本文档	24 KB
setup.exe	2019/6/21 10:15	应用程序	1,445 KB
setup.ini	2019/6/21 10:15	配置设置	22 KB
spec.ini	2019/6/21 10:15	配置设置	3 KB

Figure 6. View of the installation folder

Data Acquisition System of NSPGS2

3. Software description

3.1. Introduction to software interface

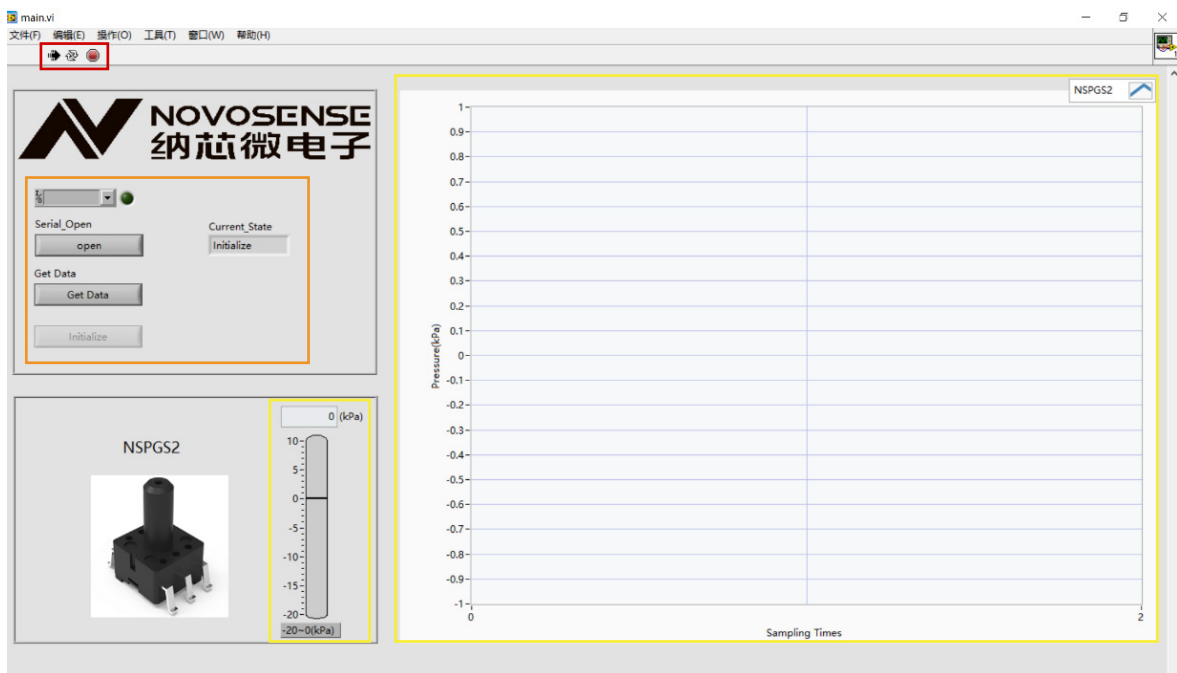

Figure 7. The interface of data acquisition software

Red box:

Click the red circular button in the box to stop the software running (The circular button will be grayed out, The left black arrow will switch to a white arrow); At this time, if you click the white arrow, you can make the software run (The circular button will turn red and the left black arrow will switch to a black arrow).

Orange box:

COM: Select RS232 serial port.
 Serial Open: Open or Close serial port.
 Get Data: Start or Stop data transmission.
 Initialize: Initialize software, Disabled by default.
 Current State: Program status display.

Yellow box:

Correctly select and open the serial port, click Get Data, the gray box will display the current pressure value which the cylindrical bar will change synchronously and the waveform on the right will display pressure changes in real time.

Data Acquisition System of NSPGS2

3.2. Software operating instructions

After the software is running, you first need to select a COM port: click the drop-down check box, select the COM port that appears after inserting the DEMO board, and click OK; Next, click Serial Open to open the COM port, and the serial port indicator on the right of the check box will be turned on; Finally, click the Get Data button to start data transmission (the Get Data button will switch to stop). At this time, if you click the stop button, data transmission will stop (the stop button will switch to the Get Data button).

Insert the DEMO board into PC and select the COM port that pops up:

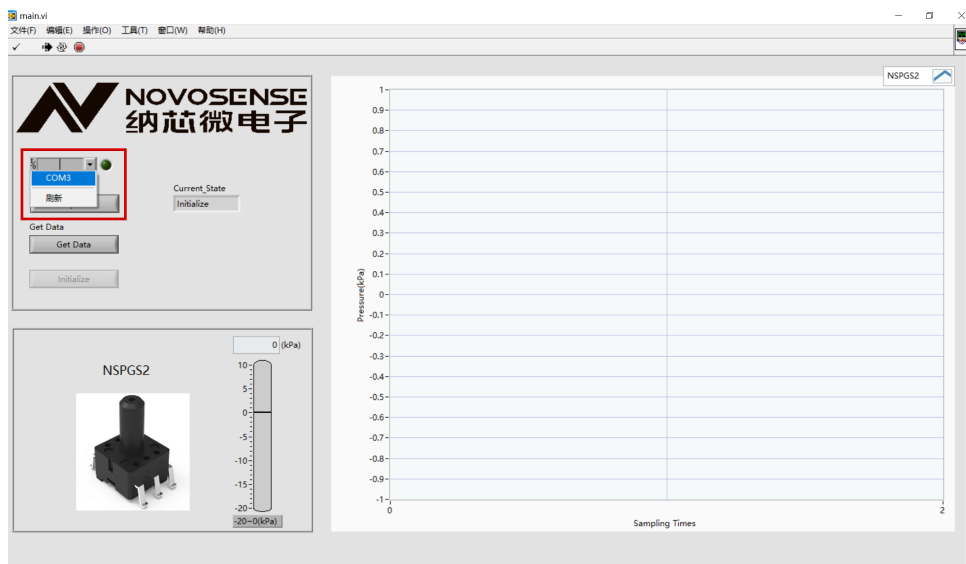

Figure 8. Selecting the COM port

Click OK:

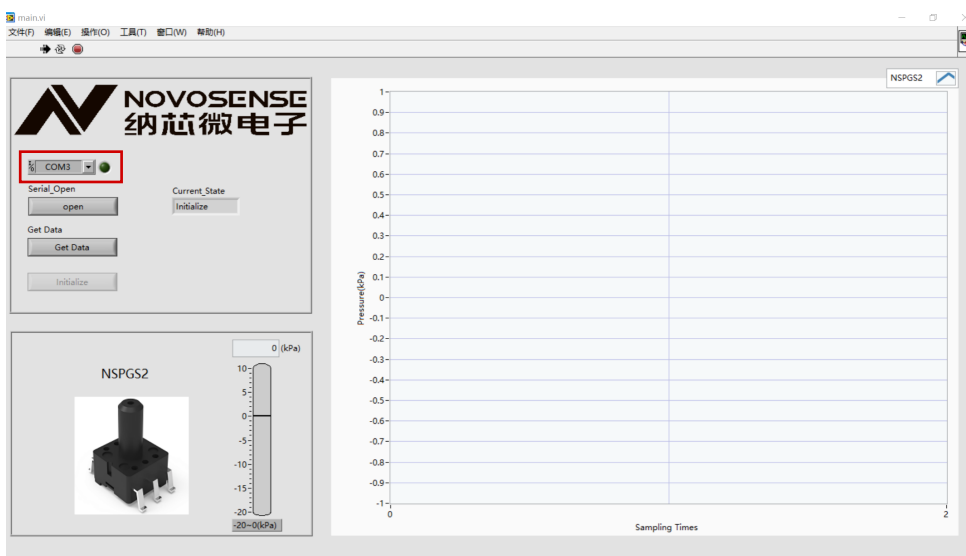

Figure 9. Confirming COM port (here number 3)

Data Acquisition System of NSPGS2

Click Serial Open to open the COM port, and the serial port indicator on the right of the check box will be turned on:

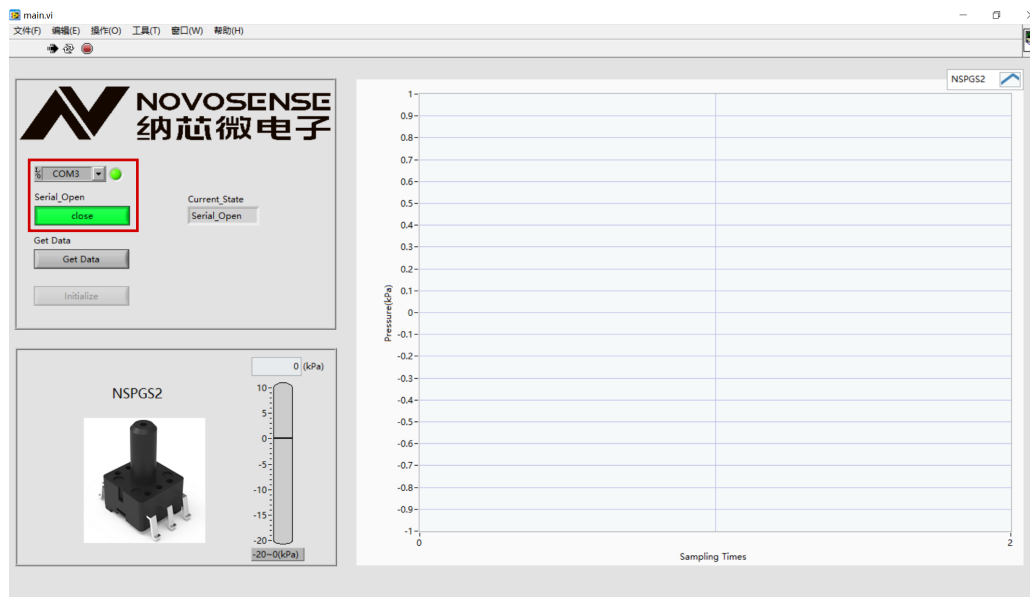

Figure 10. Open and close serial port button

Click the Get Data button to start data transmission:

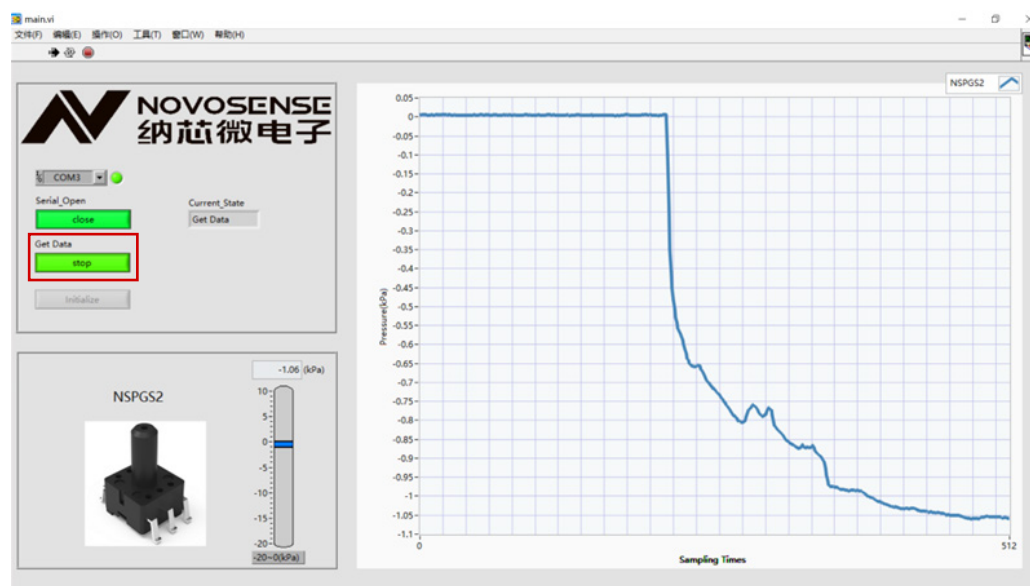

Figure 11. Start and stop acquisition button

Data Acquisition System of NSPGS2

4.Revision history

Revision	Description	Author	Date
1.0	Initial Version.	Qiuliang Shi	2023/08/14

Sales Contact: sales@novosns.com; Further Information: www.novosns.com

IMPORTANT NOTICE

The information given in this document (the “Document”) shall in no event be regarded as any warranty or authorization of, express or implied, including but not limited to accuracy, completeness, merchantability, fitness for a particular purpose or infringement of any third party’s intellectual property rights.

Users of this Document shall be solely responsible for the use of NOVOSENSE’s products and applications, and for the safety thereof. Users shall comply with all laws, regulations and requirements related to NOVOSENSE’s products and applications, although information or support related to any application may still be provided by NOVOSENSE.

This Document is provided on an “AS IS” basis, and is intended only for skilled developers designing with NOVOSENSE’ products. NOVOSENSE reserves the rights to make corrections, modifications, enhancements, improvements or other changes to the products and services provided without notice. NOVOSENSE authorizes users to use this Document exclusively for the development of relevant applications or systems designed to integrate NOVOSENSE’s products. No license to any intellectual property rights of NOVOSENSE is granted by implication or otherwise. Using this Document for any other purpose, or any unauthorized reproduction or display of this Document is strictly prohibited. In no event shall NOVOSENSE be liable for any claims, damages, costs, losses or liabilities arising out of or in connection with this Document or the use of this Document.

For further information on applications, products and technologies, please contact NOVOSENSE (www.novosns.com).

Suzhou NOVOSENSE Microelectronics Co., Ltd